

7103C
NEW AGE



7103C

Ferrari

A HYVA GROUP COMPANY

7103C

**Break the boundaries
in performance and
safety**

Link on column
Constant lifting capacity on all
main boom positions

Link on second boom
Boom negative angle allows
access to confined spaces

**Extension Quick
System and Smart
Extension Sequence**
Fast, precise, safe

425° Slewing angle
The widest slewing angle for
medium sized cranes

**Ergonomic control station
and user-friendly interface**
Comfortable, convenient and safe

Always stable
More than 40 stabilizer
combinations available

Forged hook attachment
Ruggedness and durability in all
applications



7" color display
Simple and quick access to all the functions and information

Vertical stabilizer levers
Safe and fast. Excellent supervision of stabilizing operation

Ergonomic control station engineered for maximum operator comfort and ease of operation

Dynamic Load Diagram



Crane lifting capacity always under control in all stabilizer positions.
After the truck has been stabilized, the operator selects the load weight to be lifted. The display shows the permitted crane outreach based on the truck stability and load selected.

- Improved efficiency
- Easy to use
- Optimised safety

Magic Touch

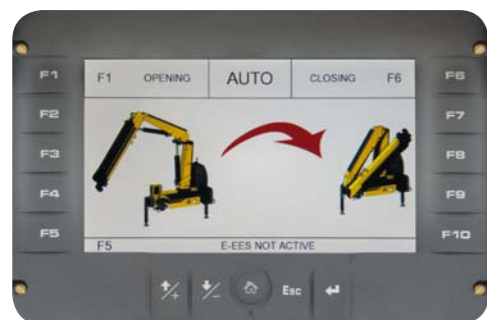

Crane Automatic folding/unfolding.
This system allows the operator to unfold the crane to a working position and fold the crane from any position to transport position by pressing a single button on the radio transmitter or display.

- Easy to start and close
- Save time
- Increased productivity and safety

High-tech development

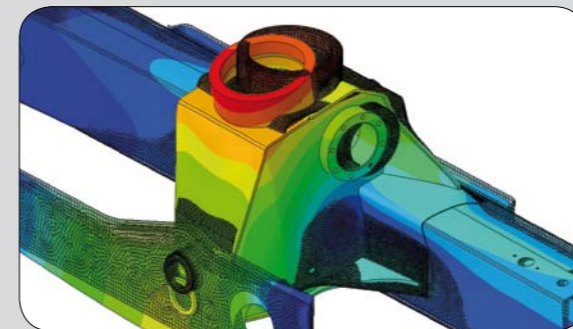

- Structures optimised for strength, weight and speed

Top Protection



- High value retention
- Top reliability

Slewing Angle

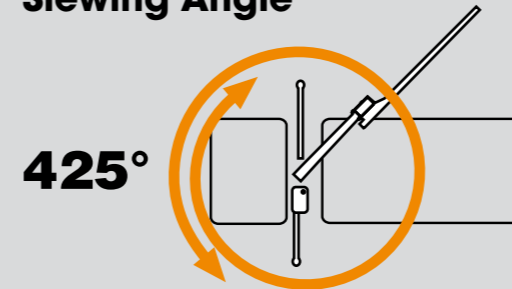

- The widest slewing angle for medium sized cranes
- Top efficiency
- Easy to use

Functional Aesthetic

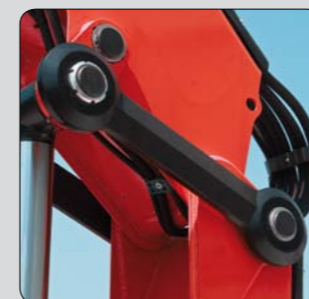

Forged double linkages on column and 2nd boom

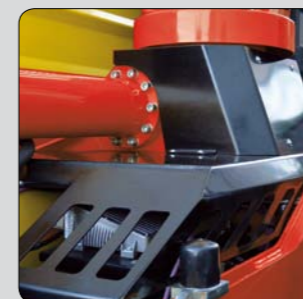

Hex Deck cover on base

Crane control system

F3XL

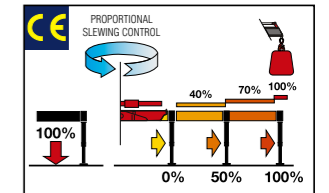

With a 3" TFT display and ergonomic keyboard, the crane operator can select optimum functional parameters. The system controls the stability with 2-step beam outreach monitoring and continuous slewing control.

F4XL+TOP

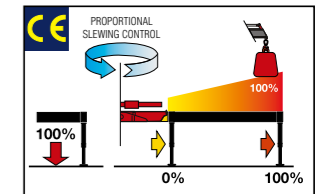

A 7" color display with integrated keyboard gives the operator a higher level of awareness of the crane operation and allows selection of the best parameters for effective use. The system detects the exact position of the beams and proportionally calculates the stability.

Wide range Radio selection



Hetronic Not CE



Hetronic CE Basic



Scanreco



Hetronic CE Graphic



Powered by Danfoss

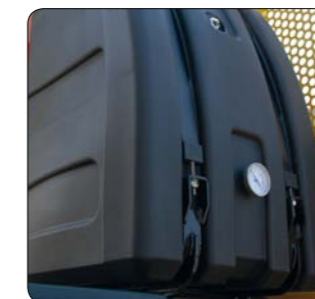

High volume oil tank made in sandwich-structured materials (PEX and PA6)



Robust column design and hoses cover

7103C *Technical data*

	Lifting Moment	Slewing Angle	Working pressure	Oil tank capacity	Max Oil flow	Max lifting height	Standard crane weight
	tm	°	bar	l	l/min	m	kg
A1	9,5	425	350	75	40	9,3	1215
A2	9,1	425	350	75	40	10,9	1305
A3	8,6	425	347	75	40	13,1	1395
A4	8,1	425	340	75	40	15,1	1480
A5	7,7	425	336	75	40	17,3	1555

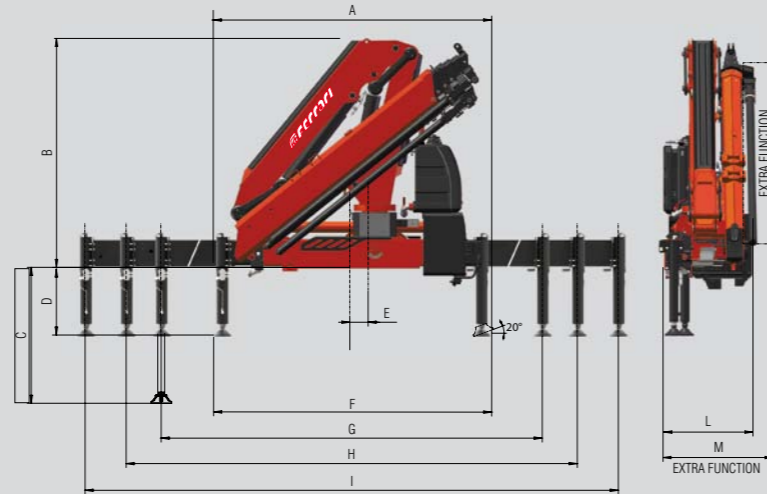

	A1	A2	A3	A4	A5
A	2290	2290	2290	2290	2290
B	2085	2085	2085	2085	2085
C	1185	1185	1185	1185	1185
D	530/585	530/585	530/585	530/585	530/585
E	160	160	160	160	160
F	2270	2270	2270	2270	2270
G	3290	3290	3290	3290	3290
H	4790	4790	4790	4790	4790
I	5755	5755	5755	5755	5755
L	800	800	800	800	845
M	845	845	845	845	910

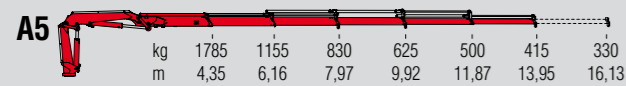
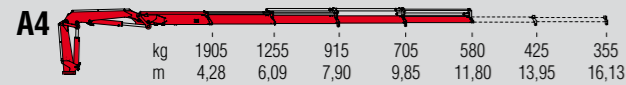
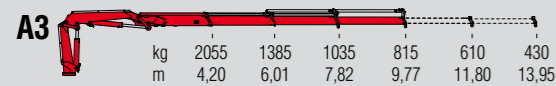
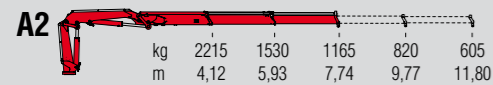
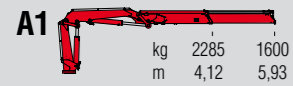

Standard

- Multifunctional radio remote control
- Sauer Danfoss PVG32
- P-PB Proportional Power Boost
- Flanged valves
- Designed in accordance with EN12999
- Design class: HC1-HD5
- Oil tank
- Manually extendable stabilizers
- Fixed stabilizer cylinders
- Swivel stabilizer foot
- Centralized greasing system
- EQS Extension Quick System
- SDV Smooth Descent Valve
- Red Power
- F3XL Crane control system (CE)

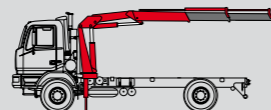

Recommended truck M.T.T. ton 12 - G.V.W. ton 12



One model, many applications



Waste handling



Construction



Fence posts, poles and landscaping



With winch



7103C

NEW AGE



Quality and environmental certified



F.lli FERRARI

Via Einstein, 8
42028 Poviglio (RE) Italy
Tel. +39 0522/486308
Fax +39 0522/486330
info@flliferrari.it
marketing@flliferrari.it
www.flliferrari.com

Dealer

Data, descriptions, and illustrations pertain only and uniquely to models sold at the time of printing of this brochure. After the date of printing, this information is purely indicative and not binding upon F.lli Ferrari. Future modifications are solely at the discretion of F.lli Ferrari and are always in compliance with applicable and pertinent safety standards. To obtain updated data, descriptions, and illustrations, contact the manufacturer or your reseller. Cranes manufactured and/or marketed by F.lli Ferrari.